

# Rilievo Piano Terra

Comune di Rose

Foglio 25 Particella 14 sub 1

Scala 1:100

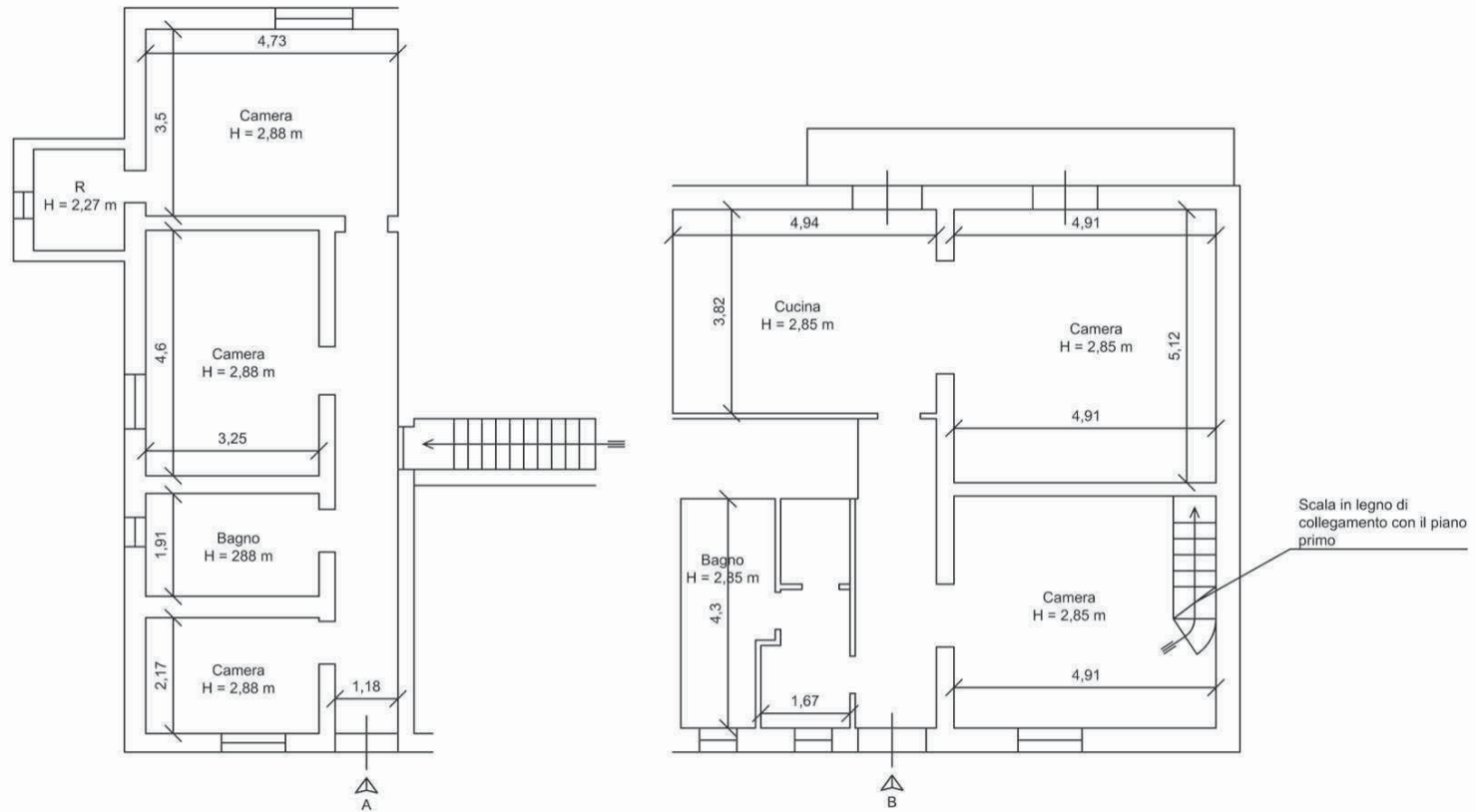

Nota bene:

1. L'unità censita in catasto con il Foglio 25 Particella 14 Sub 1 risulta di fatto frazionata in due unità per come rappresentato A e B
2. L'unità indicata con B è collegata attraverso una scala in legno con un piano primo



# Rilievo Piano Primo

Comune di Rose  
NON ACCATASTATO  
Scala 1:100

## Piazzale esterno

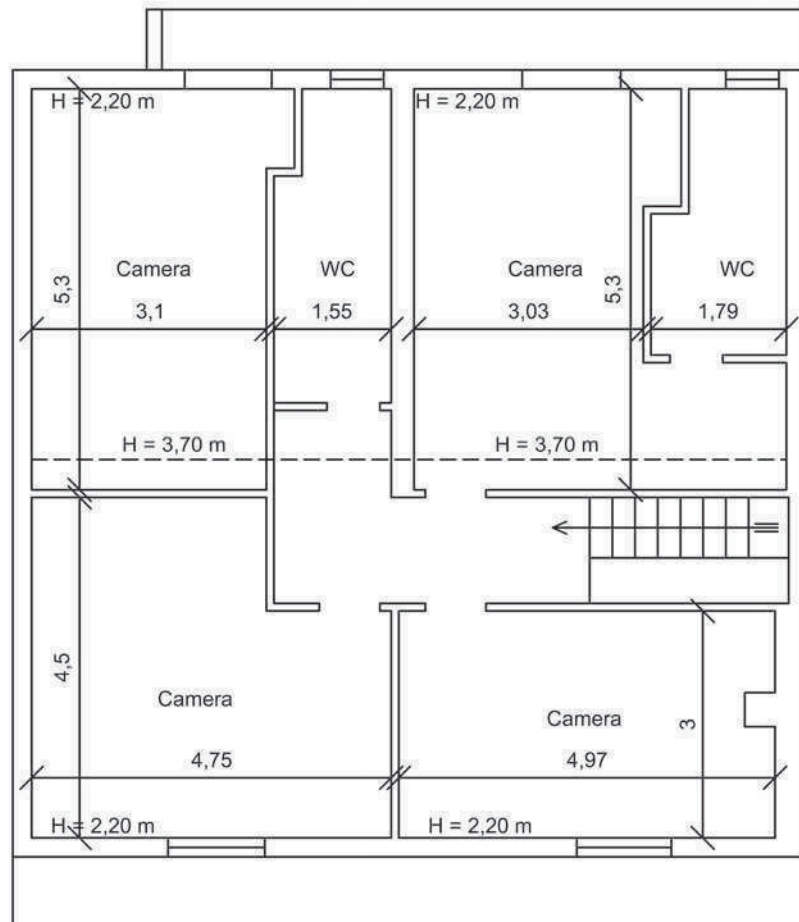

## Piazzale esterno

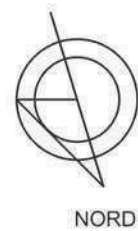

# Rilievo Piano Sottostrada

Comune di Rose

Foglio 25 Particella 14 sub 2

Scala 1:100

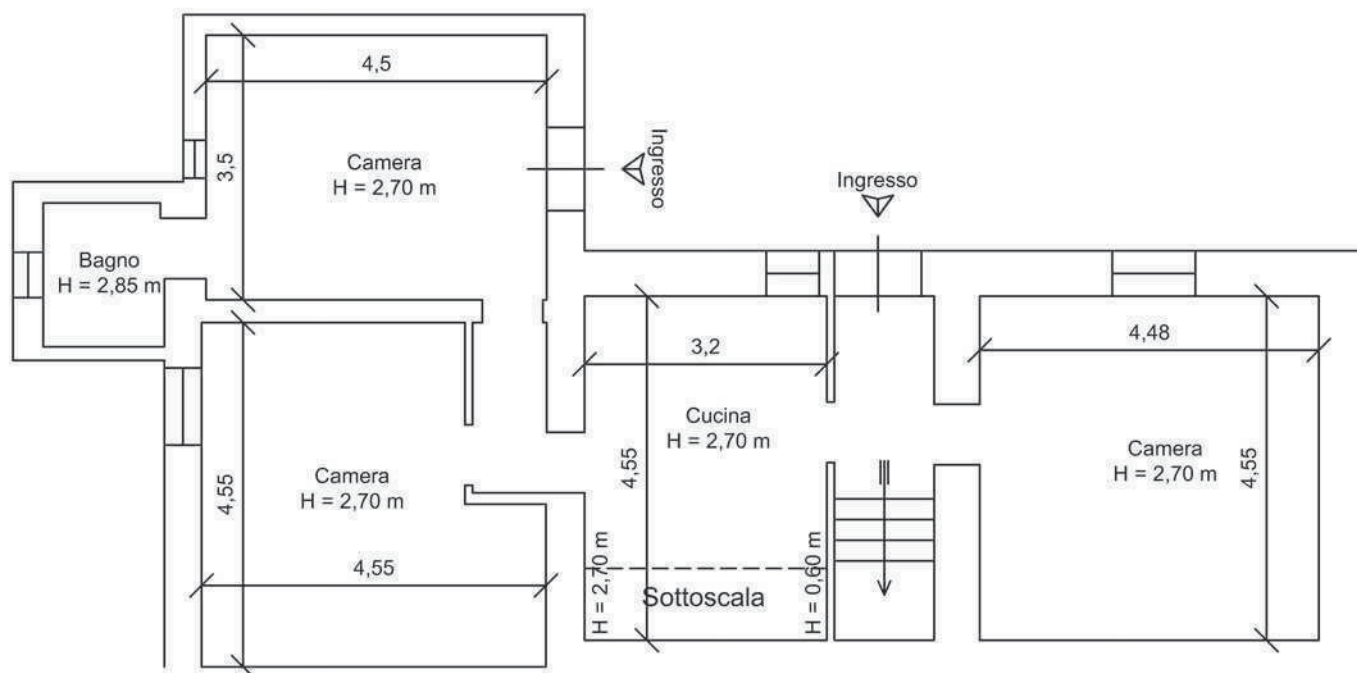

NORD

# Rilievo Piano Terra

Comune di Luzzi

Foglio 79 Particella 162 sub 1 e Particella 470 sub 2

Scala 1:100

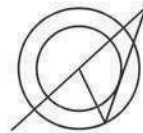
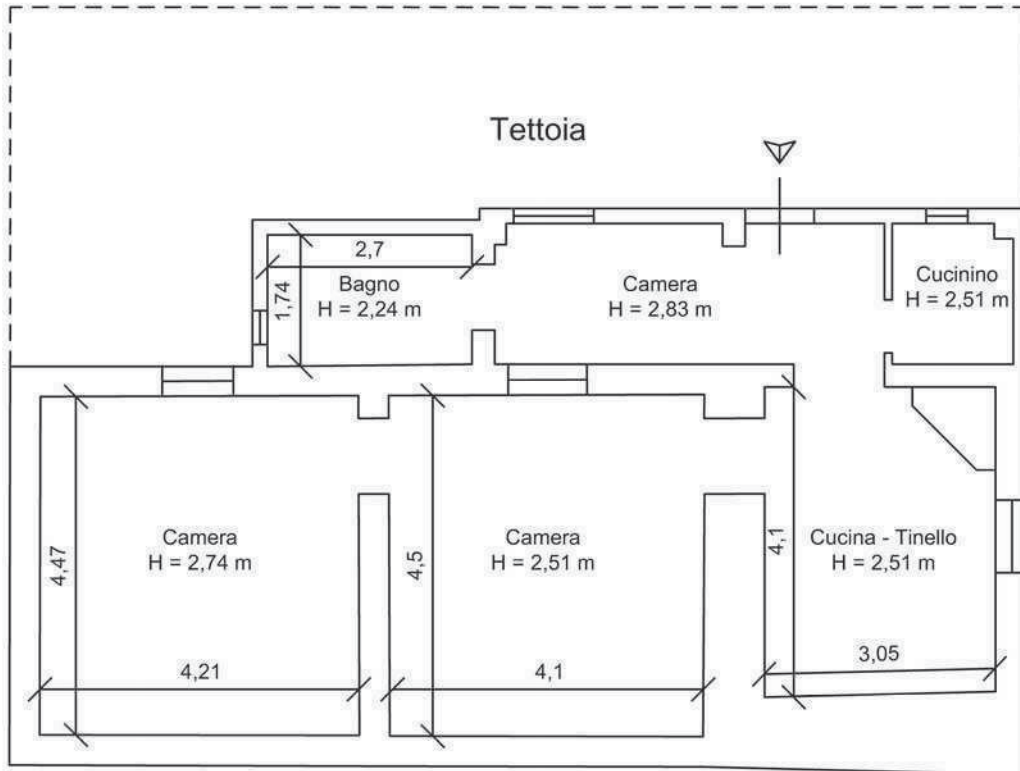

## Rilievo Piano Terra

Comune di Luzzi

Foglio 79

Particella 470 sub 1 Fabbricato collabente

Scala 1:100

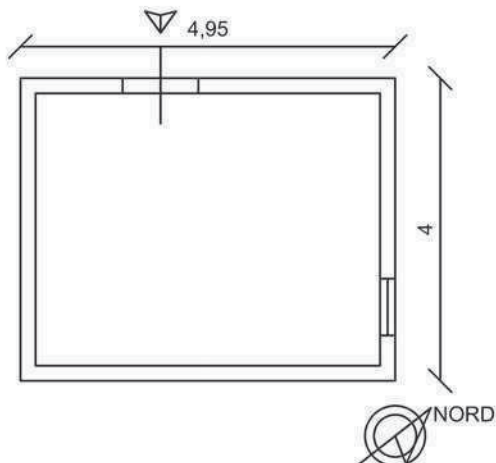

## Rilievo Piano Terra

Comune di Luzzi

Foglio 79

Particella 12 Fabbricato fatiscante

Scala 1:100

